

KIPPHEBELSCHALTER TOGGLE SWITCHES

entsprechend VG und IEC
in accordance with VG and IEC



Baureihe
Series
09



Die Kipphebelschalter von KISSLING wurden nach strengen Richtlinien entwickelt.

Sie bieten dem Anwender eine Vielzahl von Optionen. Praktisch kann fast jede Bedienungsart, Anschlussart, Dichtigkeit sowie Belastbarkeit erfüllt werden.

Typische Anwendungen:

- Anlagen- und Apparatebau
- Medizintechnik
- Nutzfahrzeuge
- Industrielle Ausrüstung
- Kommerzielle und militärische Luftfahrt
- Militärische Ausrüstung

The toggle switches available from KISSLING have been developed under strict guidelines to meet recognised international standards.

A multiplicity of options may be selected including: switching configuration, termination type, load carrying capabilities and locking combinations.

Typical applications:

- *Plant and Industrial Engineering*
- *Medical Equipment*
- *Commercial Motor Vehicles*
- *Industrial Equipment*
- *Commercial and Military Aerospace*
- *Military Equipment*

Abmessungen | Dimensions

Hebelform: Standard

Standardfarbe schwarz
lieferbar auch in rot und silber

Lever type: Standard

Standard colour: black
available in red or silver

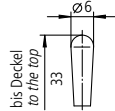

Hebelform: Verriegelung

Lever type: Lock

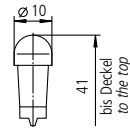

1 polig pole

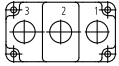

2 polig pole

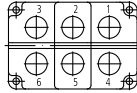

4 polig pole

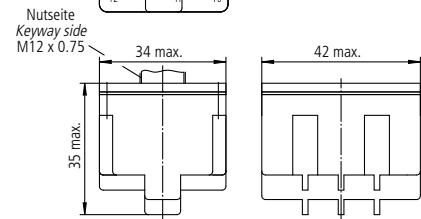
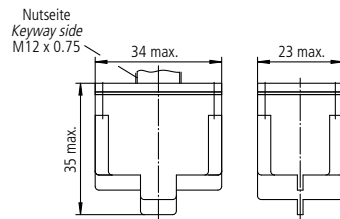
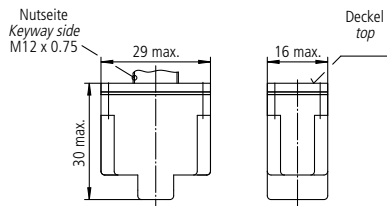
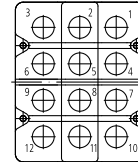

Montagebohrung:

mit Nasenscheibe

Mounting Detail:

with Locking Ring

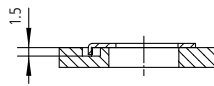
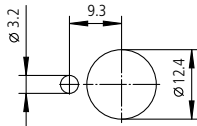

Montagebohrung:

ohne Nasenscheibe

Mounting Detail:

without Locking Ring

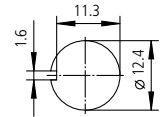

Anschluss | Connector

Schraubanschluss M 3,5 x 6 - ISO 1580

Screws M 3,5 x 6 - ISO 1580

Flachstecker DIN 46 244 - A 6,3 - 0,8

für Steckhülsen nach DIN und
KISSLING-Steckhülsegehäuse

Faston DIN 46 244 - A 6,3 - 0,8

for receptacles iaw DIN and
KISSLING-receptacles

Lötanschluss bis 2 qmm

Soldering terminal to AWG 14

Anschluss
Connection

1

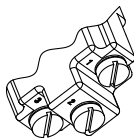

Anschluss
Connection

2

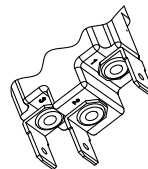

Anschluss
Connection

3

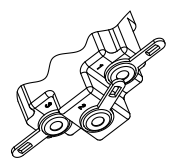

Zubehör | Accessories

Sicherheitsklappe:

Verhindert das ungewollte Betätigen des Kipphebel-
schalters. Sie ist in den Farben SIGNALORANGE,
SIGNALROT, SCHWARZ, GELB und OLIV lieferbar.
Andere Farben sowie Schrift- oder Symbolprägungen
sind auf Wunsch möglich.

Switch Guard:

Prevents accidental switching of toggle. Available in
SIGNALORANGE, SIGNALRED, BLACK, YELLOW and
OLIV.

Special Symbols and other colors available.

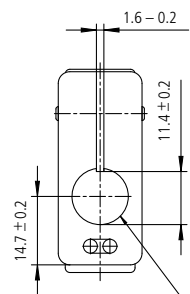

für Gewinde M12
thread size M12

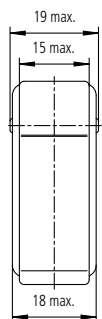
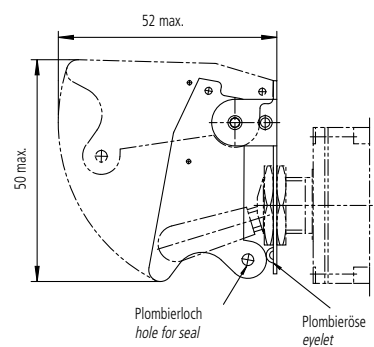

Dichtscheibe: 08.0.0.50

Zur Abdichtung der Montagebohrung

Seal Ring:

For sealing of mounting position

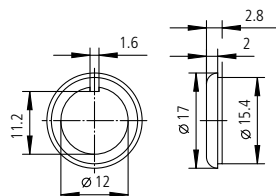

Steckhülsegehäuse:

Zum schnellen Anschluss des Kipphebelschalters, zur Erhöhung der Sicherheit und zum Schutz gegen Berühren (IP 20) der Flachstecker. Verpolschutz des Kippschalters. Verwendbar für Kippschalter mit Anschluss 2.

Receptacle:

For quick connection, increases safety. Available for switches with connection 2.

1- polig
pole
(Tiefe 41,5 | depth 41,5)

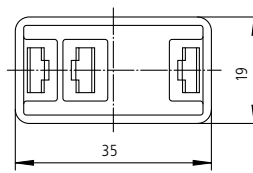

08.1.2.05

2- polig
pole
(Tiefe 41,5 | depth 41,5)

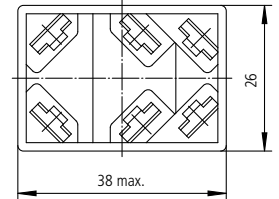

08.2.2.05

Kodierwiderstand:

Zur Sicherheitsschaltung bei GGVS-Ausführung

Hebelauswahl:

Standard - schwarz, weitere Farben auf Anfrage

Kipphebelschalter mit Kunststoffhebel,

Schutzart bis IP6K5 und Temperaturen von -35°C bis +60°C
siehe Kipphebelschalter Baureihe 07 ...

Kipphebelschalter mit Kunststoffhebel,

Schutzart bis IP6K7 und Temperaturen von -55°C bis +85°C
siehe Kipphebelschalter Baureihe 08 ...

Resistor:

For safety circuit at ADR-equipment

Range of Toggles:

Standard colour - black, alternative colours on request

Toggle Switches with plastic Toggle,

Protection to IP6K5 and a temperature range of -35°C to +60°C
please note Toggle Switches Series 07 ...

Toggle Switches with plastic Toggle,

Protection to IP6K7 and a temperature range of -55°C to +85°C
please note Toggle Switches Series 08 ...

Schaltarten, Kontaktierung

Switching styles, Connection

Schaltart Switching styles	1-polig 1-pole Hebelstellung auf Toggle position in			2-polig 2-pole Hebelstellung auf Toggle position in			4-polig 4-pole Hebelstellung auf Toggle position in		
	Nutseite keyway side	Mitte center	Nutgegenseite opposite key- way side	Nutseite keyway side	Mitte center	Nutgegenseite opposite key- way side	Nutseite keyway side	Mitte center	Nutgegenseite opposite key- way side
10	0	-	2-3	0 0	-	2-3 5-6	0 0 0 0	-	2-3 5-6 8-9 11-12
11	0 *	-	2-3	0 * 0	-	2-3 5-6	0 * 0 0 * 0	-	2-3 5-6 8-9 11-12
12	1-2 *	-	0	1-2 * 4-5	-	0 0	1-2 4-5 7-8 * 10-11	-	0 0 0 0
13	1-2	-	2-3	1-2 4-5	-	2-3 5-6	1-2 4-5 7-8 10-11	-	2-3 5-6 8-9 11-12
14	1-2 *	-	2-3	1-2 * 4-5	-	2-3 5-6	1-2 4-5 7-8 * 10-11	-	2-3 5-6 8-9 11-12
15	1-2	0	2-3	1-2 4-5	0 0	2-3 5-6	1-2 4-5 7-8 10-11	0 0 0 0	2-3 5-6 8-9 11-12
16	1-2 *	0	2-3	1-2 * 4-5	0 0	2-3 5-6	1-2 4-5 7-8 * 10-11	0 0 0 0	2-3 5-6 8-9 11-12
17	1-2 *	0	2-3 *	1-2 * 4-5	0 0	2-3 * 5-6	1-2 4-5 7-8 * 10-11	0 0 0 0	2-3 * 5-6 8-9 11-12
18	1-2	1-2	2-3	1-2 4-5	1-2 4-5	2-3 5-6	1-2 4-5 7-8 10-11	1-2 4-5 7-8 10-11	2-3 5-6 8-9 11-12
19	1-2	1-2	2-3 *	1-2 4-5	1-2 4-5	2-3 * 5-6	1-2 4-5 7-8 10-11	1-2 4-5 7-8 10-11	2-3 * 5-6 8-9 11-12
20				1-2 4-5	1-2 5-6	2-3 5-6	1-2 4-5 7-8 10-11	2-3 4-5 0 0	2-3 5-6 8-9 11-12
21				1-2 4-5	1-2 5-6	2-3 5-6			
22				1-2 * 4-5	1-2 5-6	2-3 * 5-6	1-2 4-5 7-8 * 10-11	2-3 4-5 0 0	2-3 * 5-6 8-9 11-12
23	1-2	2-3	2-3	1-2 4-5	2-3 4-5	2-3 5-6	1-2 4-5 7-8 10-11	2-3 4-5 7-8 11-12	2-3 5-6 8-9 11-12
24				1-2 4-5	1-2 5-6	2-3 * 5-6			
25				1-2 * 4-5	1-2 5-6	2-3 5-6	1-2 4-5 7-8 * 10-11	2-3 4-5 7-8 11-12	2-3 5-6 8-9 11-12
26							1-2 4-5 7-8 10-11	2-3 4-5 7-8 11-12	2-3 5-6 8-9 11-12
27							1-2 4-5 7-8 * 10-11	2-3 4-5 7-8 11-12	2-3 * 5-6 8-9 11-12







┌┐ Brücke

┌┐ Bridge

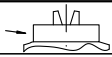
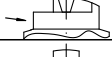
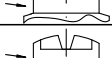
* Diese Position ist tastend, nach dem Loslassen schaltet der Kippschalter in die Ausgangsposition zurück.

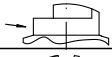
* These positions are only momentary. All others are maintained.

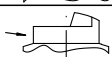
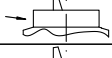
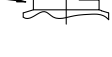
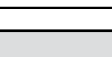
Verriegelungs-Optionen | Locking options

Verriegelungs- ausführung <i>Available locking combinations</i>	Hebelstellung auf <i>Toggle position in</i>			empfohlen für Schaltart <i>recommended for switching style</i>
	Nutseite <i>keyway side</i>	Mitte <i>center</i>	Nutgegenseite <i>opposite keyway side</i>	
A Nutseite <i>keyway side</i> 	verriegelt <i>locked</i>	verriegelt <i>locked</i>	verriegelt <i>locked</i>	15, 18, 20, 21, 23, 26
B Nutseite <i>keyway side</i> 	verriegelt <i>locked</i>	verriegelt <i>locked</i>	entriegelt <i>locked out</i>	15, 18, 19, 20, 21, 23, 24, 26
D Nutseite <i>keyway side</i> 	verriegelt <i>locked</i>	entriegelt <i>locked out</i>	verriegelt <i>locked</i>	10, 13
E Nutseite <i>keyway side</i> 	entriegelt <i>locked out</i>	verriegelt <i>locked</i>	entriegelt <i>locked out</i>	15, 16, 17, 18, 19, 20, 21, 22, 23, 24, 25, 26, 27
F Nutseite <i>keyway side</i> 	entriegelt <i>locked out</i>	entriegelt <i>locked out</i>	verriegelt <i>locked</i>	10, 11, 12, 13, 14
G Nutseite <i>keyway side</i> 	verriegelt <i>locked</i>	entriegelt <i>locked out</i>	entriegelt <i>locked out</i>	10, 13
K Nutseite <i>keyway side</i> 	entriegelt <i>locked out</i>	verriegelt <i>locked</i>	verriegelt <i>locked</i>	15, 16, 18, 20, 21, 23, 25, 26
L Nutseite <i>keyway side</i> 	entriegelt <i>locked out</i>	verriegelt zu Nutseite <i>locked to keyway side</i>	entriegelt <i>locked out</i>	15, 16, 17, 18, 19, 20, 21, 22, 23, 24, 25, 26, 27
M Nutseite <i>keyway side</i> 	entriegelt <i>locked out</i>	verriegelt zu Nutgegenseite <i>locked to opposite keyway side</i>	verriegelt <i>locked</i>	15, 16, 18, 20, 21, 23, 25, 26
N Nutseite <i>keyway side</i> 	entriegelt <i>locked out</i>	verriegelt zu Nutgegenseite <i>locked to opposite keyway side</i>	entriegelt <i>locked out</i>	15, 16, 17, 18, 19, 20, 21, 22, 23, 24, 25, 26, 27
P Nutseite <i>keyway side</i> 	verriegelt <i>locked</i>	verriegelt zu Nutseite <i>locked to keyway side</i>	entriegelt <i>locked out</i>	15, 18, 19, 20, 21, 23, 24, 26
T Nutseite <i>keyway side</i> 	verriegelt <i>locked</i>	verriegelt von Mitte zu Nutseite <i>locked from middle to keyway side</i>	verriegelt von Nutgegenseite zu Mitte <i>locked from opposite keyway side to middle</i>	15, 18, 20, 23, 26

Bestellschlüssel | Ordering Key

09 . 1 . 2 . 13 A

1 2 3 4 5

Beispiel | Example

09.1.2.13A

1 Baureihe		Series
2 Polzahl		No. Poles
3 Anschluss		Connection
4 Schaltart		Switching styles
5 Verriegelungsausführung		Available locking combinations

Technische Daten | Technical Data

	Aufbau	Construction
Gehäusewerkstoff	Duroplast GF	Housing material
Beständig gegen gebräuchliche Öle, Kraftstoffe, Hydraulikflüssigkeiten, Alkohol und Feuerlöschmittel		Resistant against most oils, fuels, hydraulic fluids, alcohol and fire extinguishing liquid
Baugröße entspricht	VG 95 318 (jedoch Metallhebel <i>but with metal toggle</i>) und <i>and</i> IEC 1 020	Construction iaw
Schutzart Innenraum	IP68 IEC 60529 / IP6K7 DIN 40050 Blatt 9 <i>Part 9</i>	Seal
Schutzart Anschlüsse	IP00 IEC 60529	Connections
	Mechanische Daten	Mechanical Data
Stromführende Teile	CuZn-Legierung	CuZn-alloy
Kontaktwerkstoff	Ag-Legierung	Ag-alloy
Umgebungstemperatur	-55°C bis +85°C	-67°F to +185°F
elektr. Lebensdauer (bei Nennlast) nach VG 95 210 Blatt 21, Schärfegrad H	100.000 Schaltspiele <i>cycles</i>	Electrical life (nominal load) iaw VG 95 210 Part 21, grade H
	Elektrische Daten	Electrical Data
Nennspannung/Dauerstrom	28 VDC, 20 A ohmsche Last <i>ohmic load</i> 28 VDC, 15 A L/R = 5 ms induktive Last <i>inductive load</i> 115 VAC, 15 A induktive Last <i>inductive load</i>	Nominal voltage/Continuous current
Schaltleistung min.	12 VDC, 20 mA	Min. switching capacity
Für kleinere Spannungen bzw. Ströme empfehlen wir Schalter mit vergoldeten Kontakten.		It is recommended to use gold-plated contacts for lower currents or voltages.



Kissling Elektrotechnik GmbH
 Bohnland 16
 D-72218 Wildberg
 Telefon: +49 (0) 70 54/2 06-0
 Telefax: +49 (0) 70 54/2 06-3 02
 E-mail: info@kissling.de
 Internet: www.kissling.de

Irrtümer und Änderungen vorbehalten